

QUOTE #:

FIXTURE:
MP1809-05-1018-INM-0001

LAMPING:
(1) A23 200W MED. BASE 120V

DIFFUSER:
ACRYLIC SMOOTH WHITE

DIAMETER:
10"

O.A. HT:

BODY HT:
18"

EXTENSION:
11 1/4"

FINISH:
PAINTED STANDARD COLOR

MATERIAL:
18 GA STEEL

DESIGNED BY: R.V.SHTEYN

DRAWN BY:
R.V.SHTEYN

OPTIONS:

QUESTIONS?
sales@mcfaddenlighting.com

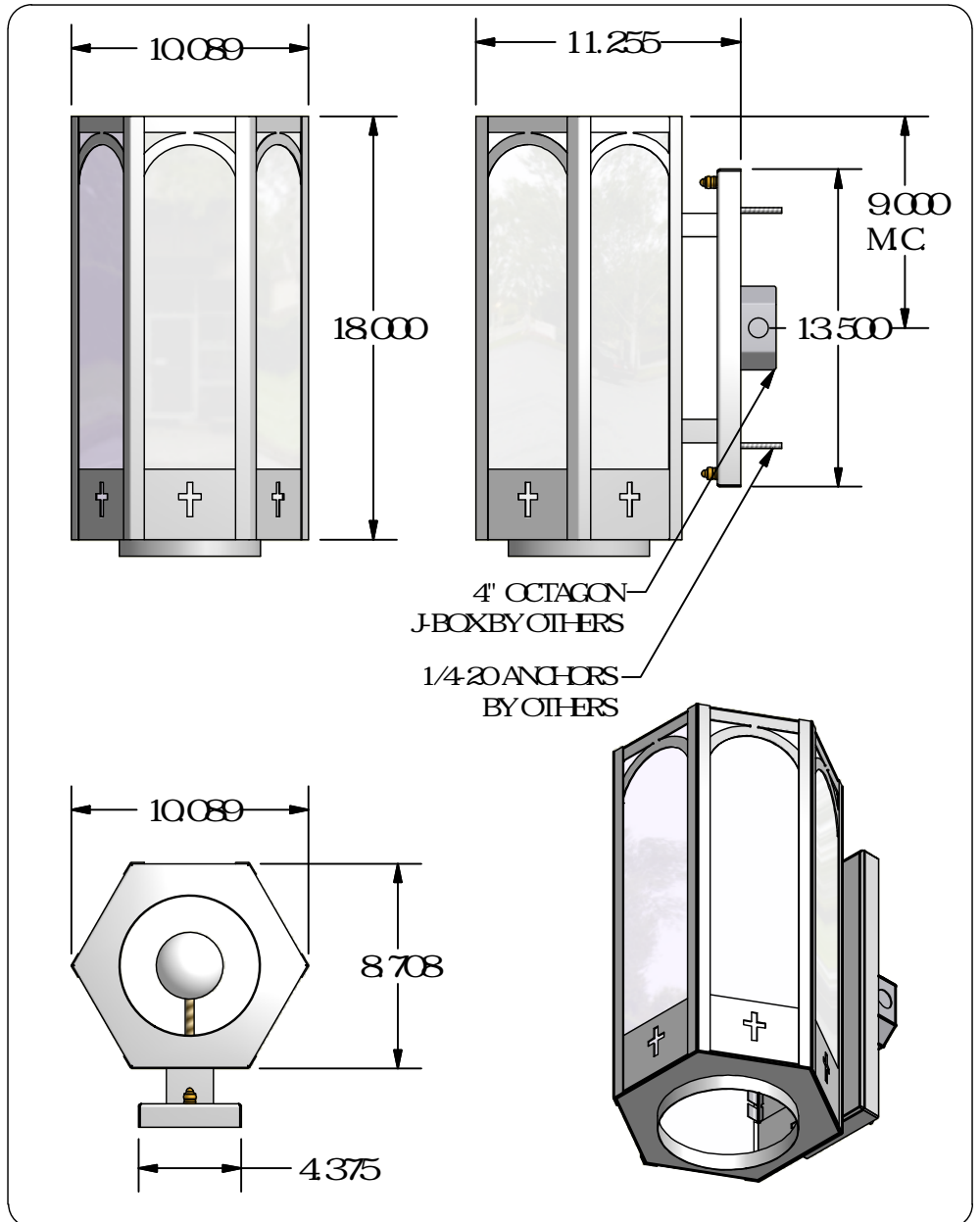

NOTES: